



sistema lievore altherr molina

SISTEMA is a modular collection composed of independent elements. So, for the first time the client can compose and adapt a sofa using imagination to suit his or her taste, needs and requirement.

There is a range of different arms, backrest, seats and accessories to choose from. The upholstered modules are available in three different backrest heights and two seat types; one mounted on a metal structure with wooden legs or calibrated steel, designed for contract. And another module with the seats reaching till the floor, with height leveling feet, for domestic spaces.

The Sofa SISTEMA is designed to obtain maximum comfort without additional pillows; nevertheless we offer well-proportioned accessories.

Thanks to the poufs, linear or angular compositions can be configured, thus to adapt to any space.

composition:

Upholstered modules: Cinched internal structure of steel, wood and plywood board coated with non-deformable polyurethane foam of different densities and polyester fibre.

Structure when carrying legs: Calibrated structure powder coated in thermoreinforced polyester in colour shadow. Adjustable feet.

Cylindrical steel legs: Legs in calibrated steel, lacquered in heat hardened polyester, colours white and black, altea blue or fluorescent orange. Height adjustable.

Leg in solid oak.

Leg in solid oak and beech.

Arm in curved beech plywood board, veneered in European oak.

Table in beech plywood, veneered in European oak.

SOFA WITH LEGS

UPHOLSTERY MODULES

SISSRP - BACKLESS MODULE

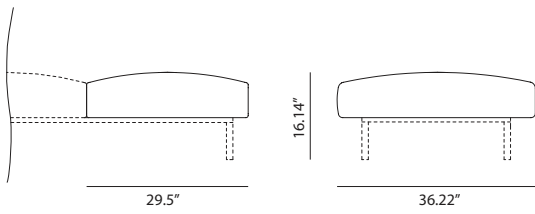

SISBP - LOW BACK MODULE

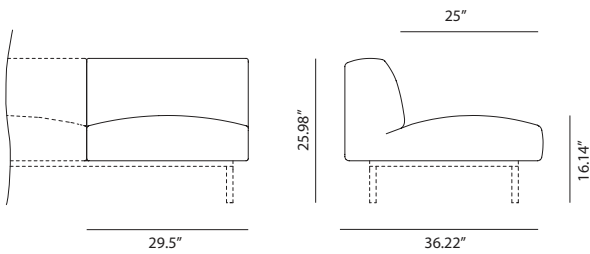

SISMP - MEDIUM BACK MODULE

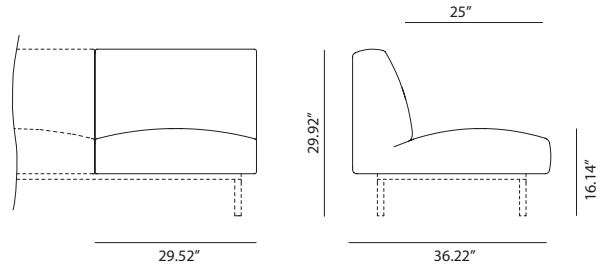

SISAP - HIGH BACK MODULE

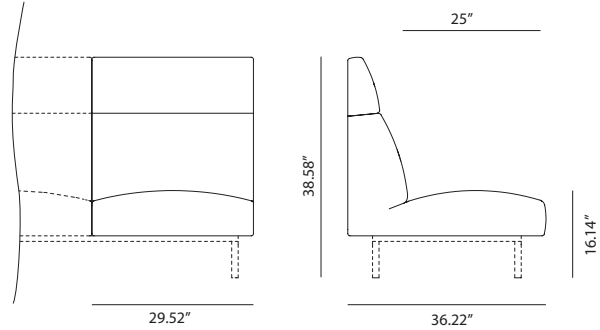

LEG OPTIONS

SISPMET - CILINDER LEGS

Calibrated steel tube powder coated with tempered polyester, in the finishes from our collection.

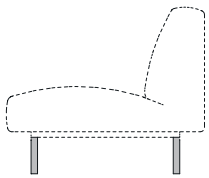

SISPF - FLUTE LEGS

Wooden solid oak legs, with carvings on the sides.

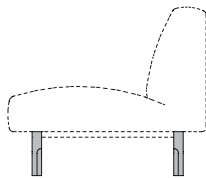

SISPRO - BEECH AND OAK LEGS

Solid oak and beech wood legs.

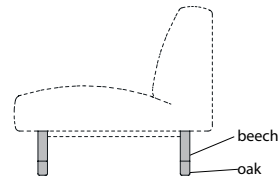

SISPTI - SCISSORS LEGS

Calibrated steel tube powder coated with tempered polyester, in the finishes from our collection.

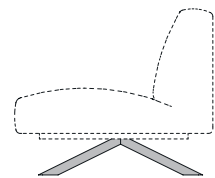
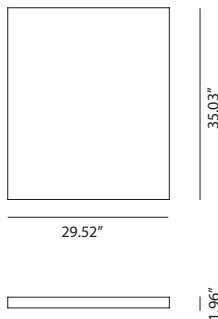

TABLE OPTIONS

SISMB - LOW TABLE

MDF veneered with oak veneer stained in the finishes from our collection.



SISMCP - WOOD BOX TABLE

Plywood natural oak table, stained with the finishes of our collection and interior plywood cylinder lacquered with the finishes of our collection. With height equalising legs.

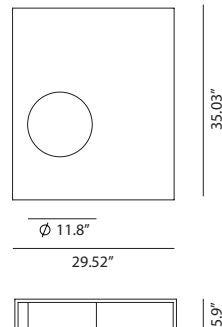

ARM OPTIONS

SISBRMP - WOOD ARM

Curved plywood arm, stained with the finishes of our collection.

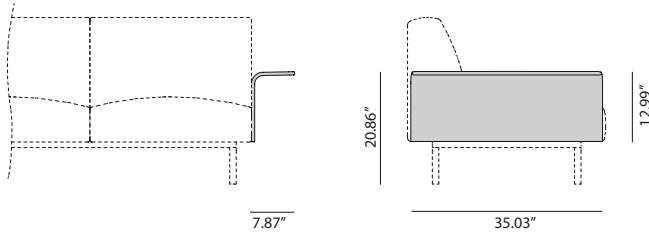

SISBRFP - NARROW ARM

Wood structure covered with polyester fibre and non-deformable, expanded polyurethane foam of varying densities. With height equalising legs.

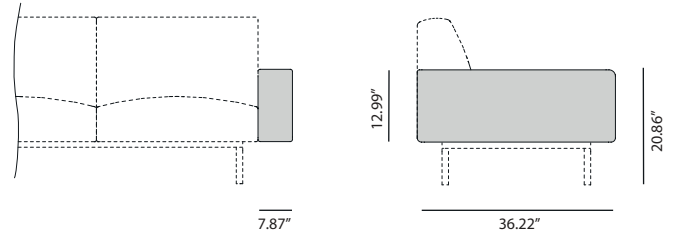

SISBRH - HIGH ARMREST UPHOLSTERED - WOOD

Natural plywood armrest stained with the finishes of our collection on the outside, and upholstered on the inside.

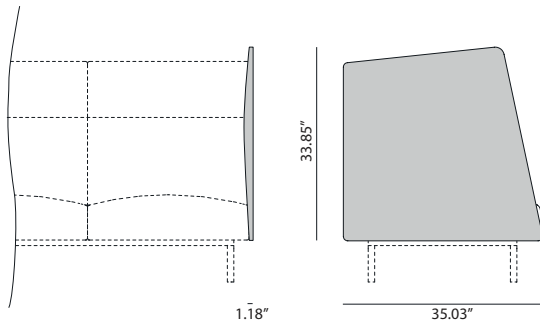

SISBRHC - HIGH FULLY UPHOLSTERED ARMREST

Natural plywood armrest, upholstered on both sides.

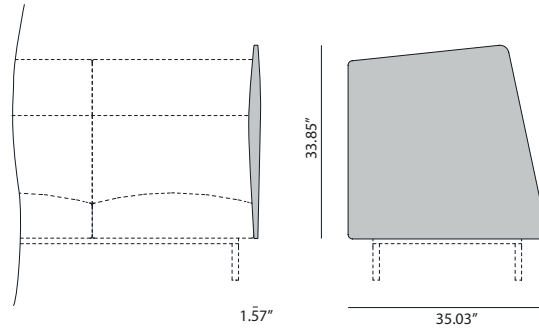

SISTEMA - SOFT UPHOLSTERY

SOFA WITH LEGS

UPHOLSTERY MODULES

SISSRPS - BACKLESS MODULE SOFT UPHOLSTERY

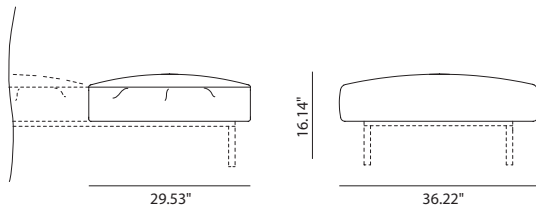

SISSRS - BACKLESS MODULE SOFT UPHOLSTERY

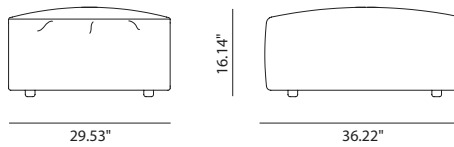

SISBPS - LOW BACK MODULE SOFT UPHOLSTERY

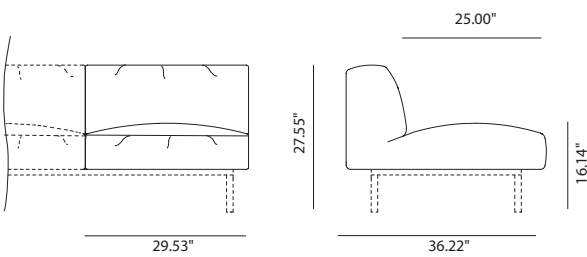

SISBS - LOW BACK MODULE SOFT UPHOLSTERY

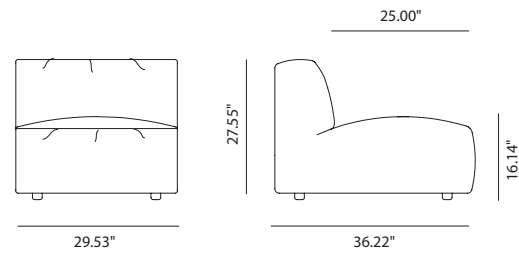

SISMPS - MEDIUM BACK MODULE SOFT UPHOLSTERY

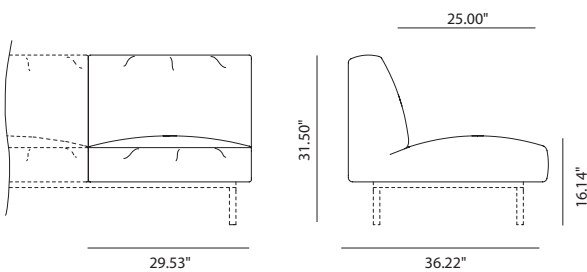

SISMS - MEDIUM BACK MODULE SOFT UPHOLSTERY

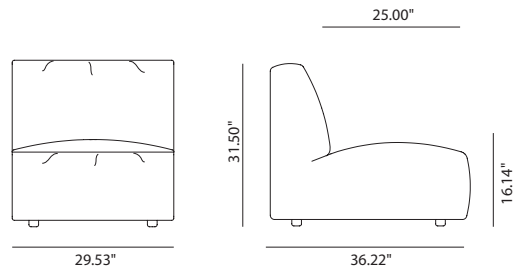

SISAPS - HIGH BACK MODULE SOFT UPHOLSTERY

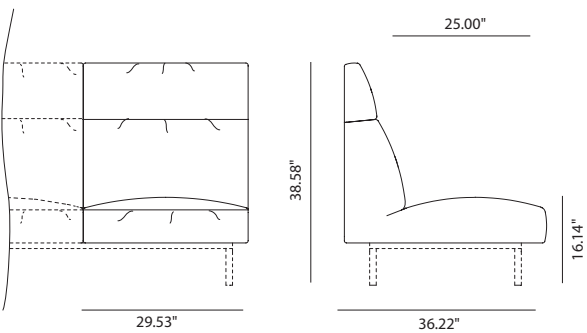

SISAS - HIGH BACK MODULE SOFT UPHOLSTERY

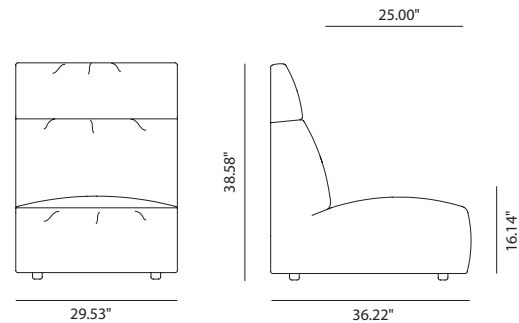

SISTEMA - SOFT UPHOLSTERY

ARM OPTIONS

SISBRFS - NARROW ARM SOFT UPHOLSTERY - SOFA WITHOUT LEGS

Wood structure covered with polyester fibre and non-deformable expanded polyurethane foam of different densities. With height equalising legs.

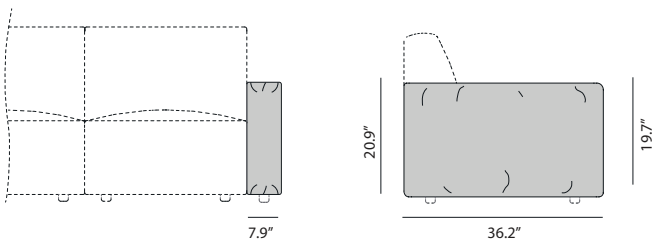

SISBRFPS - NARROW ARM SOFT UPHOLSTERY - SOFA WITH LEGS

Wood structure covered with polyester fibre and non-deformable expanded polyurethane foam of different densities.

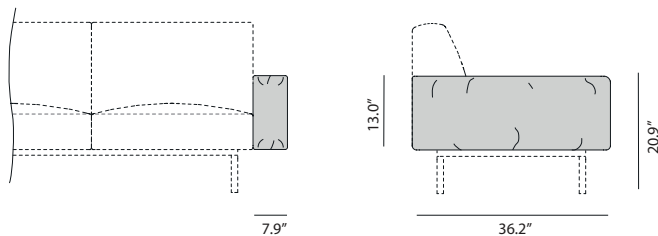

SISBRGS - WIDE ARM SOFT UPHOLSTERY - SOFA WITHOUT LEGS

Wood structure covered with polyester fibre and non-deformable expanded polyurethane foam of different densities. With height equalising legs.

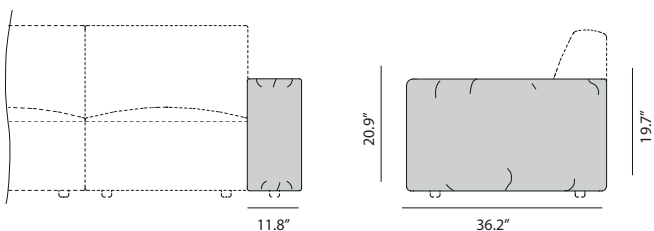

POUFS

Upholstered modules that allow angular or straight compositions.

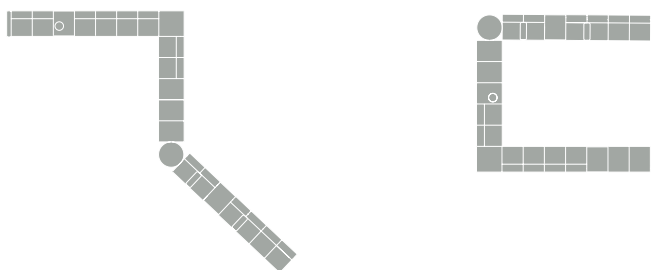

SISPORS - ROUND POUF SOFT UPHOLSTERY

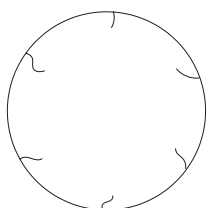

∅ 36.2"



16.1"

SISPOCS - SQUARE POUF SOFT UPHOLSTERY

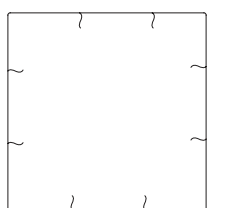

36.2"

36.2"



16.1"