

LAWRENCE BED

RODOLFO DORDONI DESIGN



Struttura: giroletto monoscocca autoportante in legno multistrati di forte spessore. Il giroletto è progettato per accogliere al suo interno molle insacchettate ricoperte in superficie da uno strato di poliuretano espanso ad alta resilienza (esente da CFC). Un pannello di multistrati forato, posto alla base delle molle, agevola l'aerazione. Testata in multistrati, imbottita con poliuretano espanso a quote differenziate ad alta densità. Tutte le parti imbottite sono rivestite con fibra termolegata ed accoppiata con tela di cotone bianca che conferisce morbidezza e soffici ta alle imbottiture isolandole dal tessuto, garantendo igiene al prodotto. Ulteriore rivestimento in tessuto tecnico traforato nella parte superiore del giroletto, che permette una maggiore traspirazione della struttura a molle. La confezione della testata   contraddistinta da cuciture dal carattere grafico e moderno. Le testate si agganciano al sommier attraverso un pratico sistema di innesto a baionetta.

Sfoderabilit : rivestimento completamente sfoderabile in tessuto o pelle. Per facilitare la rimozione delle fodere,   possibile sfilare la testata dal giroletto tramite un sistema di innesto a sgancio rapido.

Basi: portanti in estruso di alluminio (disegno esclusivo Minotti Studio) verniciate extra-lucido anti-touch nel colore Bronzo chiaro. Appoggio a terra tramite scivolanti in nylon.

N.B.: data la struttura del letto, non   possibile inserire la rete e regolare l'altezza del materasso.

Structure: one-piece, free-standing bed frame in very thick plywood. The bed frame is designed to accommodate pocket springs covered with a layer of high-resilience, (CFC-free) polyurethane foam.

A perforated plywood panel, placed under the springs, facilitates the circulation of air.

Headboard in plywood, padded with high-resilience, variable-density polyurethane foam.

All of the padded parts are covered in heat-bonded fiber laminated to white cotton fabric that lends a soft fluffiness to the padding while segregating it from the fabric, ensuring the product is both natural and hygienic. The upper part of the bed frame is covered with an additional perforated fabric covering that allows greater circulation of air around the sprung structure.

The headboard is equipped with two headrests to allow optimum reading support and comfort.

The headboard features contemporary, graphic stitchings.

The headboards are held to the sommier by means of a practical bayonet coupling.

Covers: fabric and leather covers are completely removable. To facilitate removal of the coverings, the headboard can be lifted out of the bed frame by means of a quick set and release coupling system.

Bases: weight-bearing parts in extruded aluminum (exclusive Minotti Studio design) with high-gloss, anti-fingerprint, painted Light Bronze color finish. Rests on nylon slides.

N.B.: given the architecture of the bed, it is not possible to insert a regular slatted base, or adjust the height of the mattress.

Gestell: Selbsttragender Bettrahmen in Schalenbauweise aus Schichtholz von erheblicher Dicke. Der Bettrahmen enth lt einen Taschenfederkern, der mit einer Lage aus hochelastischem Polyurethanschaum bedeckt ist (FCKW-frei).

Eine gelochte Schichtholzplatte als Unterlage der Taschenfedern sorgt f r die richtige Bel ftung.

Das Kopfteil aus Schichtholz ist mit hochdichtem, verschieden dick gesch umtem Polyurethan gepolstert. Alle Polsterteile sind mit thermofixierter Faser bezogen, kombiniert mit wei em Baumwolltuch, was der Polsterung eine weiche, elastische Note verleiht, sie aber vom Bezugsstoff trennt und damit Nat rlichkeit und Hygiene des Produktes garantiert.

Ein weiterer Bezug aus technischem Netzstoff bedeckt den oberen Teil des Bettrahmens, um eine bessere Bel ftung der Federkernstruktur zu garantieren.

Das Kopfteil hat zwei Kopfst tze, die optimales Komfort zum Lesen bieten.

Das Kopfteil hat eine moderne graphische Absteppung.

Die Kopfteile sind mit dem Sommier mit einem praktischen Bayonetsystem verbunden.

Abziehbarkeit: Stoff- oder Lederbezug vollkommen abziehbar. Um das Abziehen der Bez ge zu erleichtern, kann das Kopfteil  ber ein praktisches, schnelles Stecksystem vom Untergestell abgenommen werden.

Grundgestell: Tragende Teile aus Aluminiumpressguss (exklusives Design von Minotti Studio), Bronzfarbig lackiert mit gl nzendem Anti-Touch-Finish. Bodenauflage mit Gleitschutz aus Nylon.

N.B.: Die Struktur des Bettes erlaubt es nicht, einen Bettrost einzuf gen und die Matratzenh he zu regulieren.

Structure : tour de lit monocoque autoportante en contreplaqu  de forte  paisseur. Le tour de lit est con u pour accueillir des ressorts ensach s dont la surface est recouverte d'une couche de polyur thane expans  haute r silience (sans CFC).

Un panneau de multiplis perfor , favorisant l'a ration, est situ    la base des ressorts.

T te de lit en multiplis, rembourrage en polyur thane expans    densit  diff renci e et haute densit .

Toutes les parties rembourr es sont recouvertes de fibre thermoli e doubl e de toile de coton blanc donnant avantagent de souplesse et de moelleux aux rembourrages en les isolant du tissu, afin de garantir un produit naturel et hygi nique. Sous-housse en tissu technique perfor  dans la partie sup rieure du tour de lit, permettant   la structure   ressorts de mieux respirer.

La t te de lit est  quipp e avec deux appuie-t tes offrant un appui suppl mentaire id al pour la lecture.

La confection de la t te de lit est caract ris e par des coutures au caract re graphique et moderne.

Les t tes du lit sont croch e au sommier avec une pratique syst me   baionettes.

D houssage : rev tement enti rement d houssable en tissu ou cuir. Pour faciliter le d houssage, on peut d solidariser la t te du tour de lit gr ce   un m canisme d'enclenchement et d clenchement rapide.

Bases : portantes en aluminium extrud  (d'apr s un dessin exclusif de Minotti Studio), peinture extra-brillante anti-trace de couleur Bronze Clair. Compl t e de patins glisseurs en nylon.

N.B. :  tant donn  la structure du lit, il n'est pas possible d'introduire de sommier   lattes ni de r gler la hauteur du matelas.

ALLUMINIO | ALUMINUM

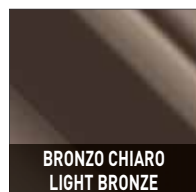

BRONZO CHIARO
LIGHT BRONZE

La base del letto è costituita da un moderno sommier H 17 cm caratterizzato dalla presenza di molle insacchettate che, insieme al materasso "Comfort H25", favorisce un'elevata qualità del riposo notturno. L'appoggio a terra è affidato ad essenziali quanto sofisticate lame in metallo verniciate extra-lucido, anti-touch nel colore Bronzo Chiaro.

The base of the bed includes the modern cm 17 -high base with pocket springs that, along with the "Comfort H25" mattress, promises an extremely restful night's sleep. The bed rests on simple, but elegant metal blades with an extra-glossy anti-fingerprint Light Bronze colour finish.

Das Bettgestell besteht aus einem modernen Polsterbett H 17 cm mit Taschenfedern, das gemeinsam mit der Matratze "Comfort H25" eine optimale Qualität des Nachtschlafs garantiert. Die Bodenaufgabe besteht aus ganz einfachen, aber raffinierten, Metallleisten, mit hochglänzend Anti-fingerprint hell Bronze farbiger Lackierung.

La base du lit est constituée d'un moderne sommier H 17 cm caractérisé par la présence de ressorts ensachés qui, alliés au matelas "Comfort H25", favorisent un sommeil de bonne qualité. Il repose sur des lames essentielles et sophistiquées, en métal avec peinture extra-brillante anti-trace couleur Bronze Clair.

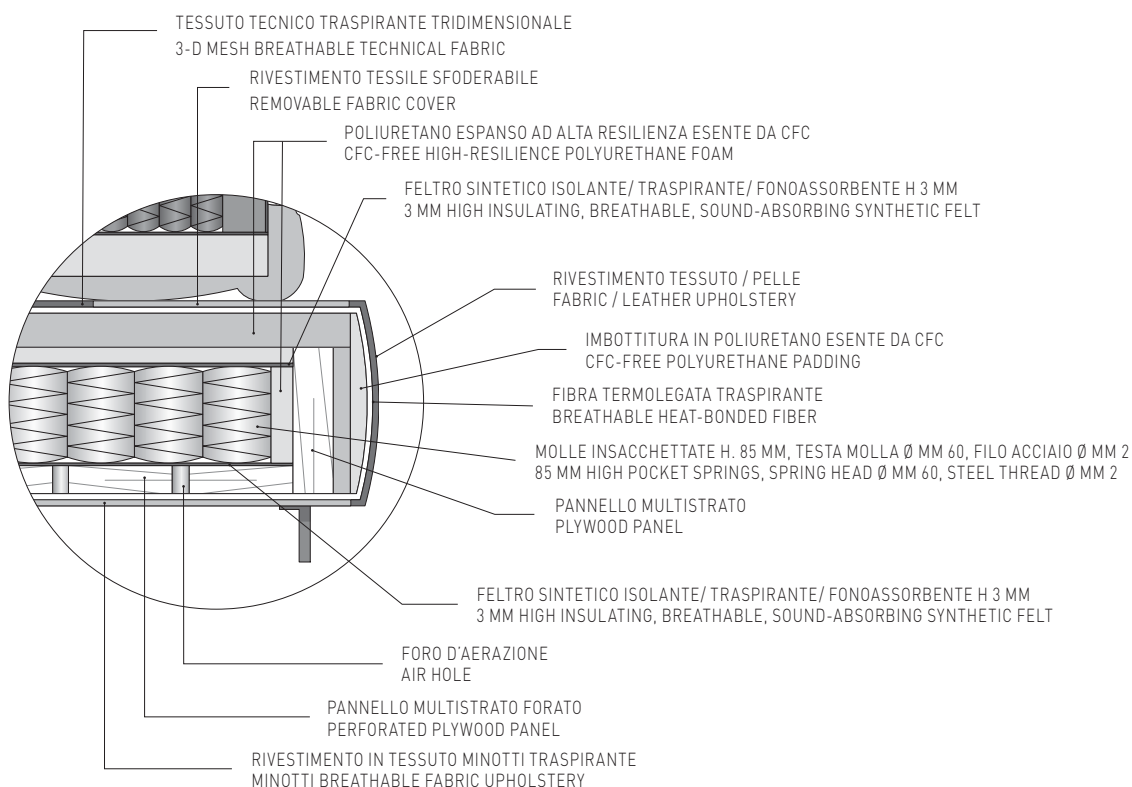
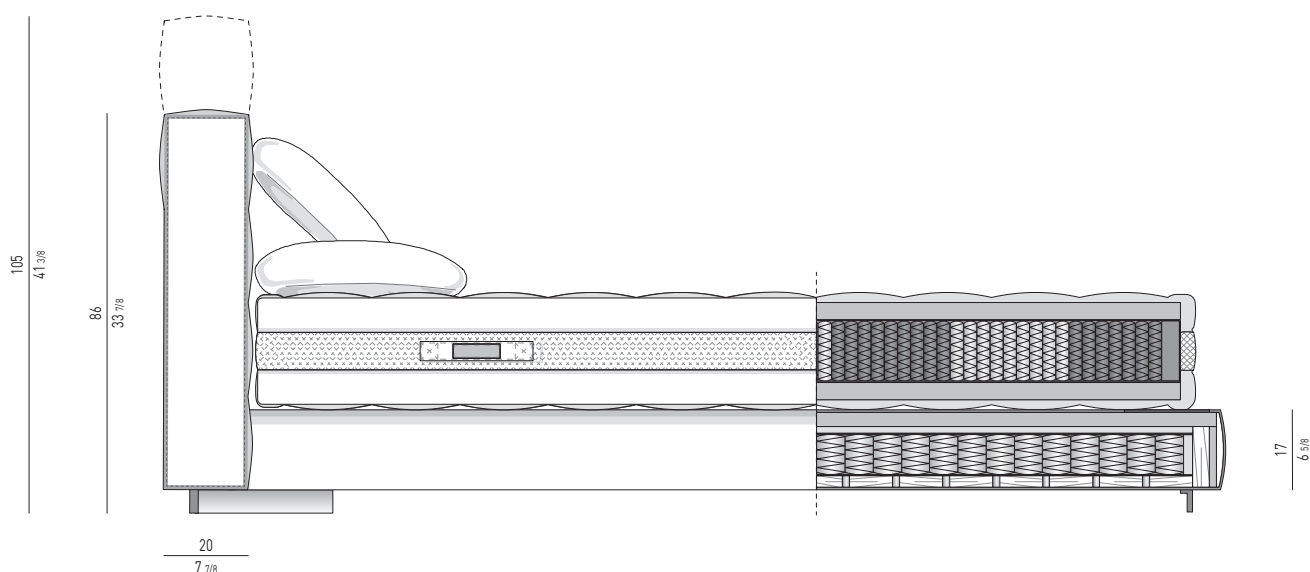

TESTATE DISPONIBILI / AVAILABLE HEADBOARDS

Sono disponibili testate con diverse misure, che consentono di realizzare sia configurazioni simmetriche che asimmetriche, con la possibilità di abbinare anche rivestimenti differenti.

La parte posteriore della testata presenta le cuciture decorative solo nella parte superiore, come mostrato nel disegno. Il retro della testata è comunque rivestito nel medesimo tessuto o pelle utilizzati per la parte anteriore della testata.

Headboards in several sizes are available, to allow designing symmetrical and asymmetrical configurations. It is also possible to combine different fabric and leather option for upholstery.

The rear of the headboard only features decorative stitchings in the top part, as shown in the drawings. Anyhow it is upholstered in the same fabric or leather used for the headboard front.

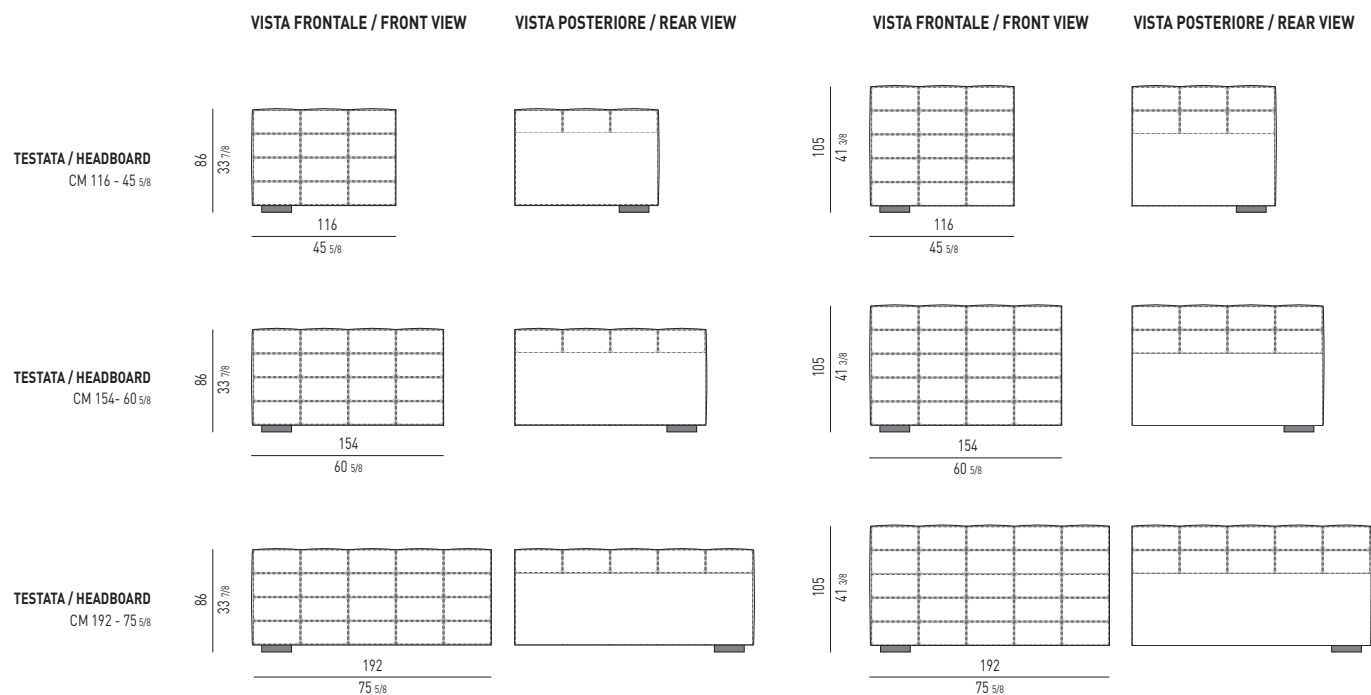

ESEMPI DI ABBINAMENTO DI TESTATE SIMMETRICHE CON SOMMIER 169X211 / HOW TO COMBINE SYMMETRICAL HEADBOARDS WITH THE SOMMIER 169X211

TESTATA LARGHEZZA MASSIMA CM 384
LARGEST HEADBOARD CM 384
(N. 2 TESTATE/HEADBOARDS CM 192 - SX+DX)

SOMMIER CM 169X211(Materasso/Mattress cm 160x200)

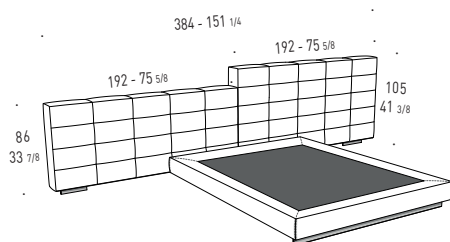

TESTATA LARGHEZZA INTERMEDIA CM 308
MEDIUM HEADBOARD 308
(N. 2 TESTATE/headboards CM 154 - SX+DX)

SOMMIER CM 169X211(Materasso/Mattress cm 160x200)

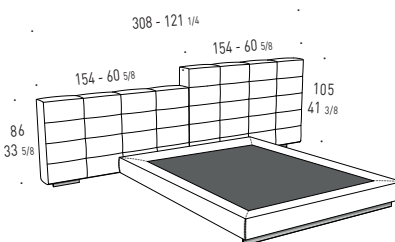

TESTATA LARGHEZZA MINIMA CM 232
SMALLEST HEADBOARD CM 232
(N. 2 TESTATE/headboards CM 116 - SX+DX)

SOMMIER CM 169X211(Materasso/Mattress cm 160x200)

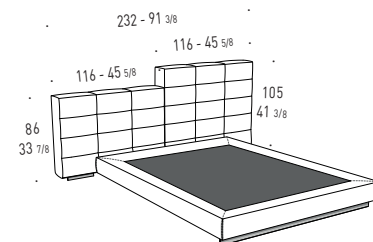

È POSSIBILE COMBINARE TESTATE DI ALTEZZE DIVERSE O ALTEZZE UGUALI / IT IS POSSIBLE TO COMBINE HEADBOARDS WITH THE SAME HEIGHTS OR WITH DIFFERENT HEIGHTS

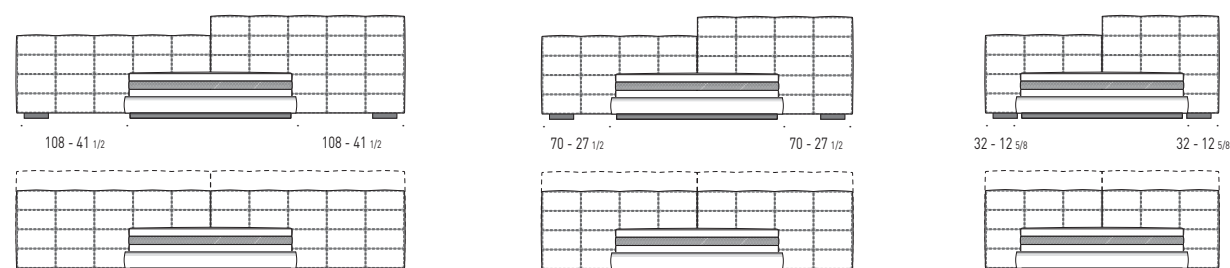

ESEMPI DI ABBINAMENTO DI TESTATE SIMMETRICHE CON SOMMIER 189X211 / HOW TO COMBINE SYMMETRICAL HEADBOARDS WITH THE SOMMIER 189X211

TESTATA LARGHEZZA MASSIMA CM 384
LARGEST HEADBOARD CM 384
(N. 2 TESTATE/HEADBOARDS CM 192 - SX+DX)

SOMMIER CM 189X211(MATERASSO/MATRESS CM 180X200)

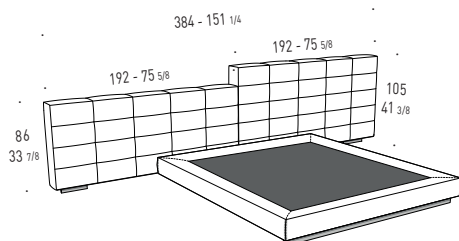

TESTATA LARGHEZZA INTERMEDIA CM 308
MEDIUM HEADBOARD CM 308
(N. 2 TESTATE/HEADBOARDS CM 154 - SX+DX)

SOMMIER CM 189X211(MATERASSO/MATRESS CM 180X200)

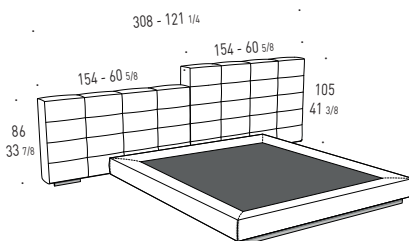

TESTATA LARGHEZZA MINIMA CM 232
SMALLEST HEADBOARD CM 232
(N. 2 TESTATE/HEADBOARDS CM 116 - SX+DX)

SOMMIER CM 189X211(MATERASSO/MATRESS CM 180X200)

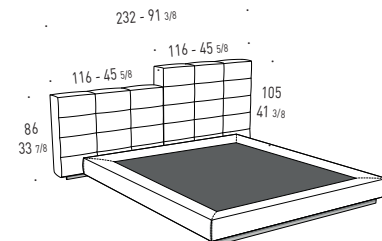

È POSSIBILE COMBINARE TESTATE DI ALTEZZE DIVERSE O ALTEZZE UGUALI / IT IS POSSIBLE TO COMBINE HEADBOARDS WITH THE SAME HEIGHTS OR WITH DIFFERENT HEIGHTS

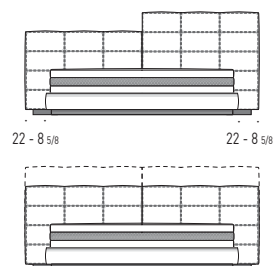
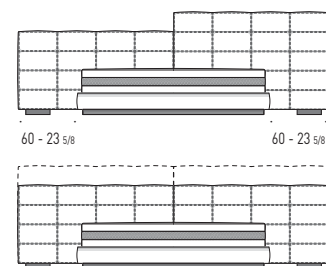
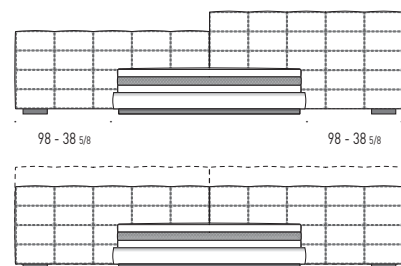

ESEMPI DI ABBINAMENTO DI TESTATE SIMMETRICHE CON SOMMIER 209X211 / HOW TO COMBINE SYMMETRICAL HEADBOARDS WITH THE SOMMIER 209X211

TESTATA LARGHEZZA MASSIMA CM 384
LARGEST HEADBOARD CM 384
(N. 2 TESTATE/headboards CM 192 - SX+DX)

SOMMIER CM 209X211(Materasso/Matress cm 200x200)

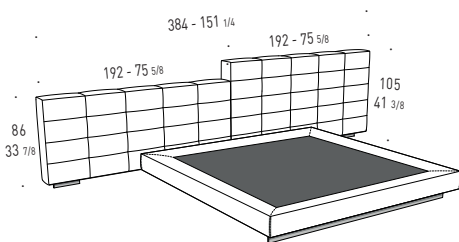

TESTATA LARGHEZZA INTERMEDIA CM 308
MEDIUM HEADBOARD CM 308
(N. 2 TESTATE/headboards CM 154 - SX+DX)

SOMMIER CM 209X211(Materasso/Matress cm 200x200)

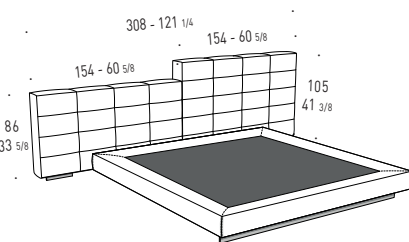

TESTATA LARGHEZZA MINIMA CM 232
SMALLEST HEADBOARD CM 232
(N. 2 TESTATE/headboards CM 116 - SX+DX)

SOMMIER CM 209X211(Materasso/Matress cm 200x200)

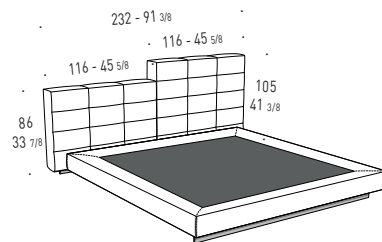

È POSSIBILE COMBINARE TESTATE DI ALTEZZE DIVERSE O ALTEZZE UGUALI / IT IS POSSIBLE TO COMBINE HEADBOARDS WITH THE SAME HEIGHTS OR WITH DIFFERENT HEIGHTS

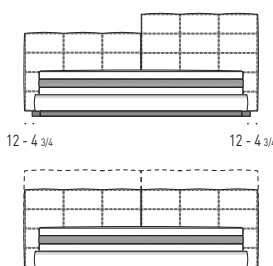
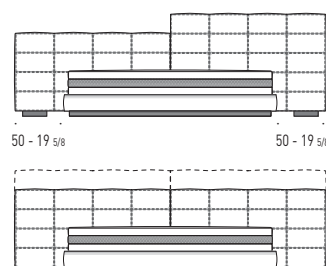
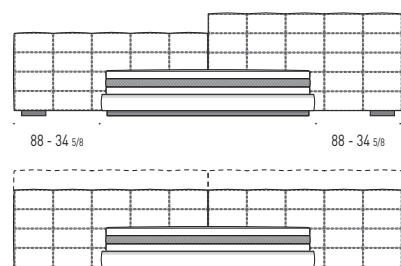

ESEMPI DI ABBINAMENTO DI TESTATE SIMMETRICHE CON SOMMIER QUEEN SIZE 162X214 / HOW TO COMBINE SYMMETRICAL HEADBOARDS WITH THE SOMMIER QUEEN SIZE 162X214

TESTATA LARGHEZZA MASSIMA CM 384
LARGEST HEADBOARD CM 384
(N. 2 TESTATE/HEADBOARDS CM 192 - SX+DX)

SOMMIER CM 162X214(MATERASSO/MATRESS CM 152X203)

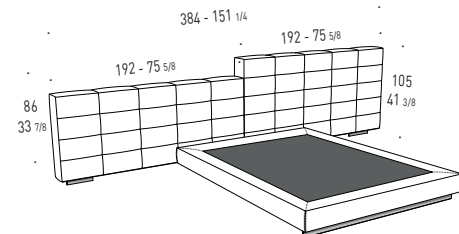

TESTATA LARGHEZZA INTERMEDIA CM 308
MEDIUM HEADBOARD CM 308
(N. 2 TESTATE/HEADBOARDS CM 154 - SX+DX)

SOMMIER CM 162X214(MATERASSO/MATRESS CM 152X203)

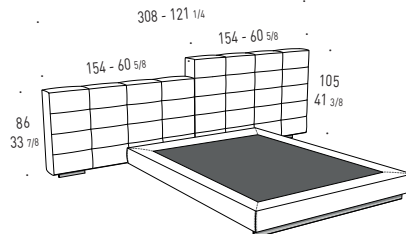

TESTATA LARGHEZZA MINIMA CM 232
SMALLEST HEADBOARD CM 232
(N. 2 TESTATE/headboards CM 116 - SX+DX)

SOMMIER CM 162x214(Materasso/Matress cm 152x203)

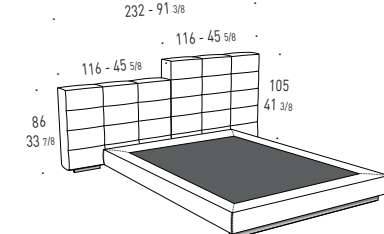

È POSSIBILE COMBINARE TESTATE DI ALTEZZE DIVERSE O ALTEZZE UGUALI / IT IS POSSIBLE TO COMBINE HEADBOARDS WITH THE SAME HEIGHTS OR WITH DIFFERENT HEIGHTS

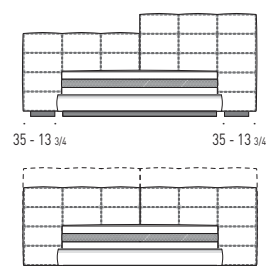
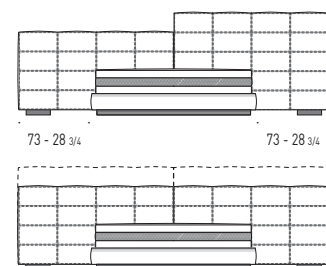
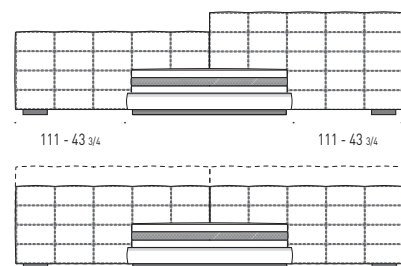

ESEMPI DI ABBINAMENTO DI TESTATE SIMMETRICHE CON SOMMIER KING SIZE 202X214 / HOW TO COMBINE SYMMETRICAL HEADBOARDS WITH THE SOMMIER KING SIZE 202X214

TESTATA LARGHEZZA MASSIMA CM 384
LARGEST HEADBOARD CM 384
(N. 2 TESTATE/HEADBOARDS CM 192 - SX+DX)

SOMMIER CM 202X214(MATERASSO/MATRESS CM 193X203)

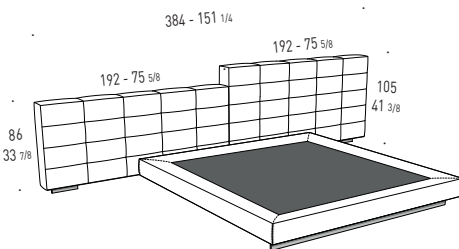

TESTATA LARGHEZZA INTERMEDIA CM 308
MEDIUM HEADBOARD CM 308
(N. 2 TESTATE/HEADBOARDS CM 154 - SX+DX)

SOMMIER CM 202X214(MATERASSO/MATRESS CM 193X203)

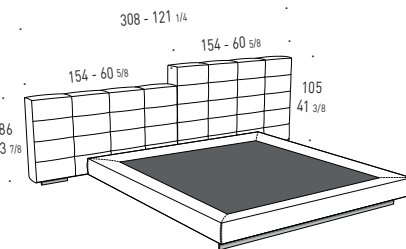

TESTATA LARGHEZZA MINIMA CM 232
SMALLEST HEADBOARD CM 232
(N. 2 TESTATE/HEADBOARDS CM 116 - SX+DX)

SOMMIER CM 202X214(MATERASSO/MATRESS CM 193X203)

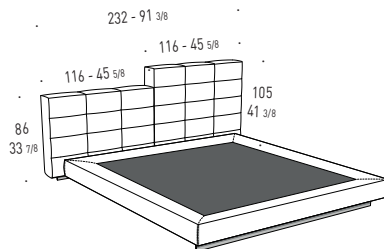

È POSSIBILE COMBINARE TESTATE DI ALTEZZE DIVERSE O ALTEZZE UGUALI / IT IS POSSIBLE TO COMBINE HEADBOARDS WITH THE SAME HEIGHTS OR WITH DIFFERENT HEIGHTS

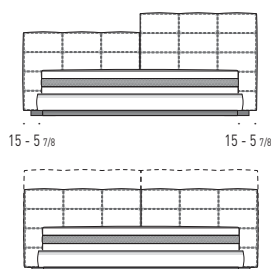
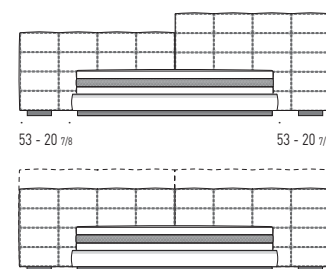
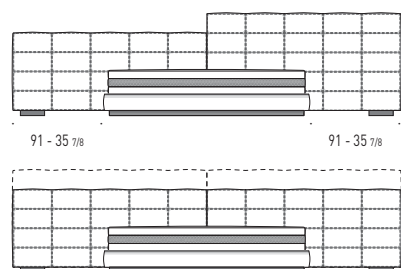

VISTA FRONTALE / FRONT VIEW

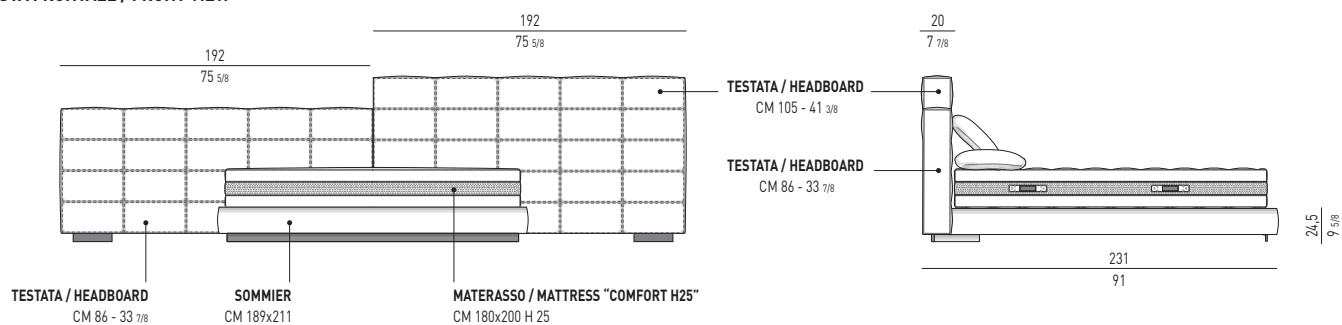

VISTA POSTERIORE / REAR VIEW

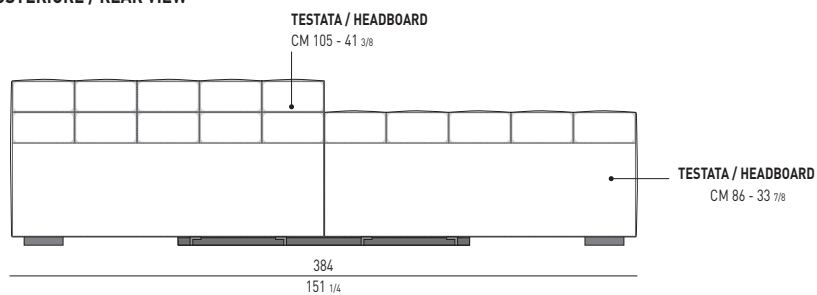

ESEMPI DI ABBINAMENTO DI TESTATE ASIMMETRICHE CON SOMMIER 169X211 / HOW TO COMBINE ASYMMETRICAL HEADBOARDS WITH THE SOMMIER 169X211

Le stesse combinazioni possono ovviamente essere realizzate utilizzando i sommier nelle altre misure, per i quali andranno appositamente considerati gli ingombri effettivi. Naturally, the same combinations can be made using the other-sized sommier, for which the actual measures must be taken into consideration.

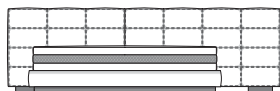

TESTATA / HEADBOARD CM 270
CM 116X86 SX + CM 154X86 DX

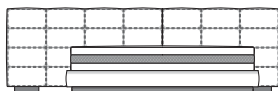

TESTATA / HEADBORD CM 270
CM 154X86 SX + CM 116X86 DX

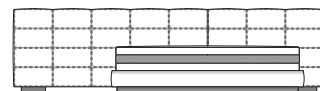

TESTATA / HEADBOARD CM 308
CM 192X86 SX + CM 116X86 DX

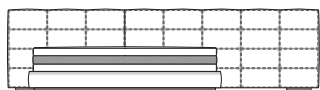

TESTATA / HEADBOARD CM 308
CM 116X86 SX + CM 192X86 DX

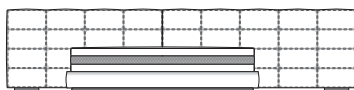

TESTATA / HEADBORD CM 346
CM 154X86 SX + CM 192X86 DX

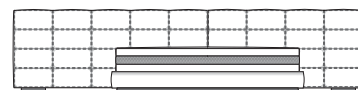

TESTATA / HEADBOARD CM 346
CM 192X86 SX + CM 154X86 DX

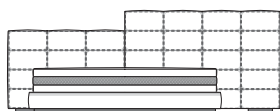

TESTATA / HEADBOARD CM 270
CM 116X86 SX + CM 154X105 DX

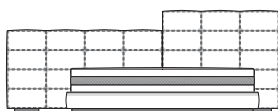

TESTATA / HEADBORD CM 270
CM 154X86 SX + CM 116X105 DX

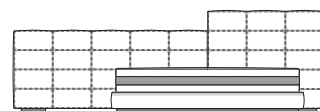

TESTATA / HEADBOARD CM 308
CM 192X86 SX + CM 116X105 DX

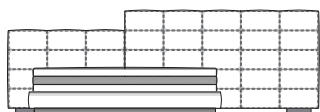

TESTATA / HEADBOARD CM 308
CM 116X86 SX + CM 192X105 DX

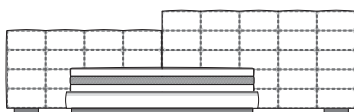

TESTATA / HEADBOARD CM 346
CM 154X86 SX + CM 192X105 DX

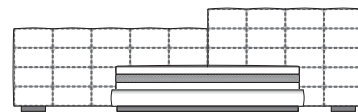

TESTATA / HEADBOARD CM 346
CM 192X86 SX + CM 154X105 DX

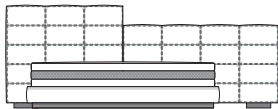

TESTATA / HEADBOARD CM 270
CM 116X105 SX + CM 154X86 DX

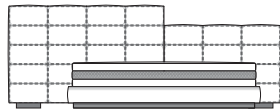

TESTATA / HEADBOARD CM 270
CM 154X105 SX + CM 116X86 DX

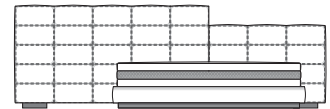

TESTATA / HEADBOARD CM 308
CM 192X105 SX + CM 116X86 DX

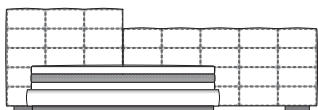

TESTATA / HEADBOARD CM 308
CM 116X105 SX + CM 192X86 DX

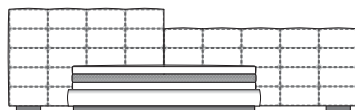

TESTATA / HEADBOARD CM 346
CM 154X105 SX + CM 192X86 DX

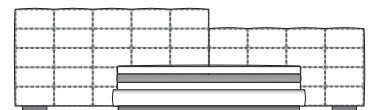

TESTATA / HEADBOARD CM 346
CM 192X105 SX + CM 154X86 DX

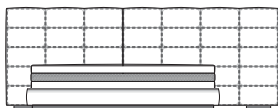

TESTATA / HEADBOARD CM 270
CM 116X105 SX + CM 154X105 DX

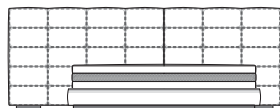

TESTATA / HEADBOARD CM 270
CM 154X105 SX + CM 116X105 DX

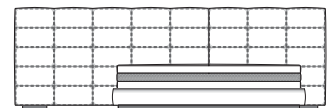

TESTATA / HEADBOARD CM 308
CM 192X105 SX + CM 116X105 DX

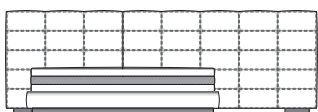

TESTATA / HEADBOARD CM 308
CM 116X105 SX + CM 192X105 DX

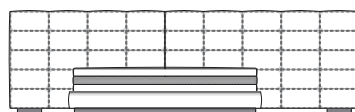

TESTATA / HEADBOARD CM 346
CM 154X105 SX + CM 192X105 DX

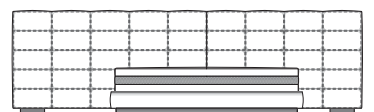

TESTATA / HEADBOARD CM 346
CM 192X105 SX + CM 154X105 DX

SOMMIER CM 169x211
SOMMIER INTERO / ONE-PIECE SOMMIER

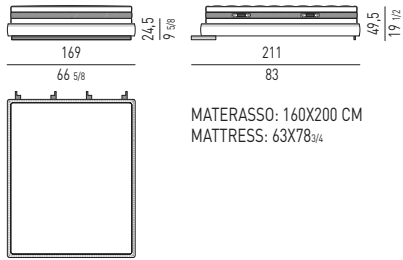

SOMMIER DIVISO/ TWO-PIECES SOMMIER

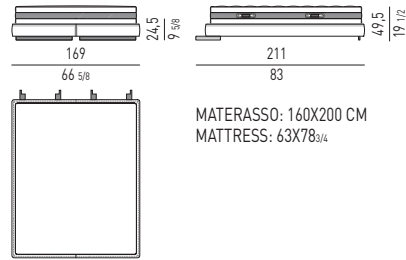

SOMMIER CM 189x211
SOMMIER INTERO / ONE-PIECE SOMMIER

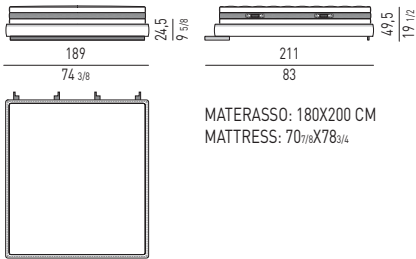

SOMMIER DIVISO/ TWO-PIECES SOMMIER

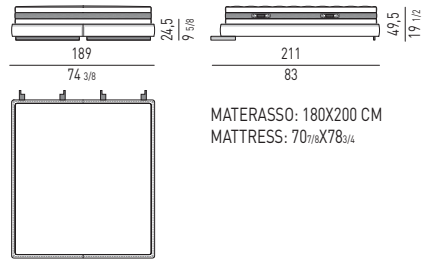

SOMMIER CM 209x211
SOMMIER INTERO / ONE-PIECE SOMMIER

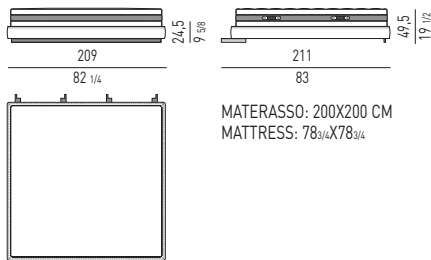

SOMMIER DIVISO/ TWO-PIECES SOMMIER

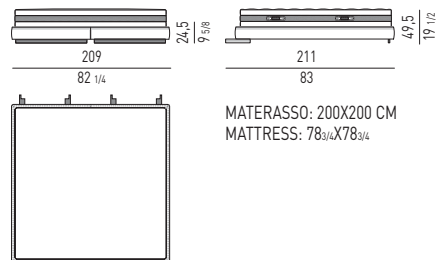

SOMMIER "QUEEN SIZE" CM 162x214
SOMMIER INTERO / ONE-PIECE SOMMIER

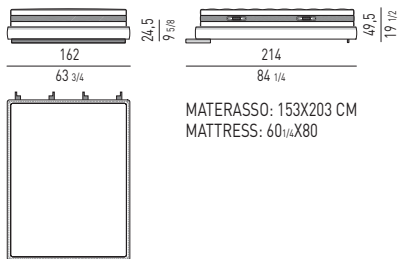

SOMMIER DIVISO/ TWO-PIECES SOMMIER

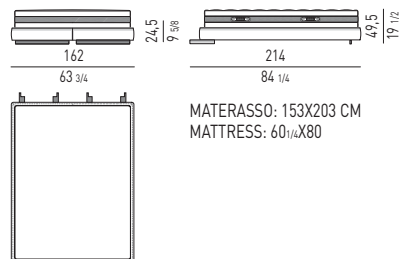

SOMMIER "KING SIZE" CM 202x214
SOMMIER INTERO / ONE-PIECE SOMMIER

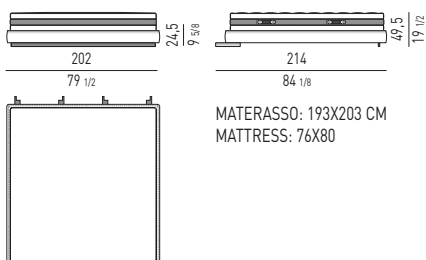

SOMMIER DIVISO/ TWO-PIECES SOMMIER

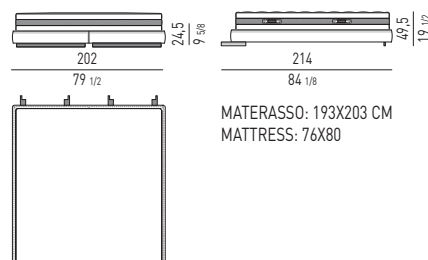

Minotti

SOMMIER INTERO

La testata viene agganciata attraverso un sistema di innesto e sgancio rapido.

ONE PIECE SOMMIER

The headboard is fastened through a quick set and release coupling system.

SOMMIER EINTEILIG

Das Kopfteil wird mit einem schnellen Stecksystem am Gestell angebracht.

SOMMIER ENTIER

La tête de lit se fixe à l'aide d'un mécanisme d'enclenchement et déclenchement rapide.

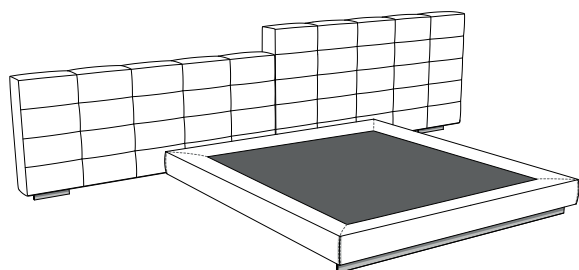
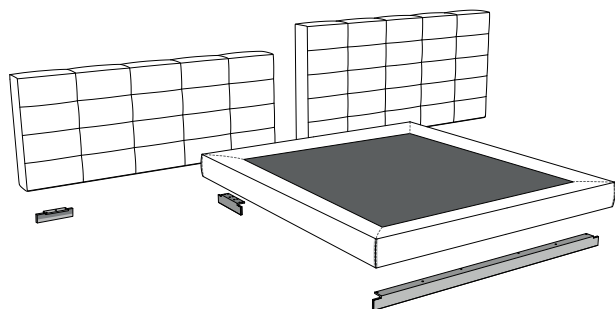

SOMMIER DIVISO IN DUE ELEMENTI

Versione con sommier diviso in due elementi, al fine di facilitare la consegna. I due elementi si congiungono tra loro a mezzo di un'apposita cremagliera. La testata viene agganciata attraverso un sistema di innesto e sgancio rapido. I due elementi sommier vengono consegnati già rivestiti.

SOMMIER DIVIDED INTO TWO PIECES

To facilitate delivery, a version with the sommier in two pieces is also available. The two pieces are joined by means of a special connecting device. The headboard is fastened through a quick set and release coupling system. The two sommier pieces are delivered with upholstery already in place.

SOMMIER ZWEIFTEILIG

Variante mit dem Sommier in zwei Teile zerlegt ist, um die Lieferung zu vereinfachen. Die beiden Elemente werden über ein spezifisches, zahnradähnliches Scharnier miteinander verbunden. Das Kopfteil wird mit einem schnellen Stecksystem am Gestell angebracht. Beide Sommier-Teile werden bereits bezogen geliefert.

SOMMIER DIVISÉ EN DEUX PARTIES

Version avec sommier divisé en deux parties afin de faciliter la livraison. Les deux parties s'encastrent à l'aide d'un système de fixation à crémaillère. La tête de lit se fixe à l'aide d'un mécanisme d'enclenchement et déclenchement rapide. Les deux parties du sommier sont livrées avec leur revêtement.

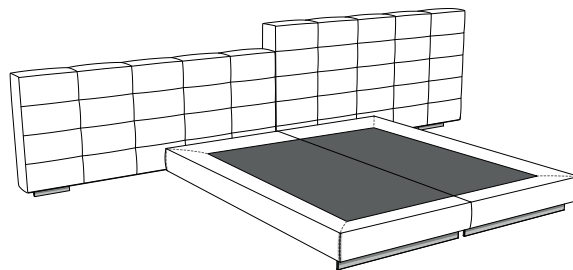
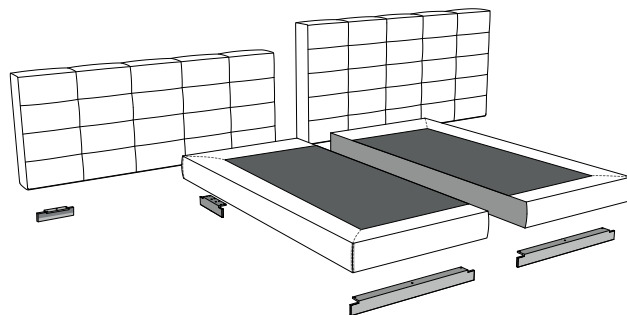

MATERASSO / MATTRESS "COMFORT" H25

Materasso ortopedico h cm 25, con sette zone di portanza differenziata. Il materasso è costituito da molle "supermicro" insacchettate, ricoperte in superficie da uno strato di poliuretano espanso ad alta resilienza a quote differenziate (Memory Foam). La tasca di contenimento della molla in tessuto anallergico, chiusa con ultrasuoni, rende il molleggio del materasso particolarmente confortevole. Il materasso è reversibile e rivestito in tessuto jacquard "Minotti", colore crema, antiacaro e antibatterico. Rivestimento con cerniera completamente sfoderabile e lavabile.

Orthopedic mattress, 25 cm h, with seven different weight-bearing zones. The mattress is comprised of "supermicro" pocket springs, covered by a surface layer of high resilience variable-density polyurethane (Memory Foam). Pockets containing the springs are made from hypoallergenic fabric, sealed by ultrasound, providing especially comfortable suspension. The mattress is reversible and is covered in cream color "Minotti" jacquard fabric that is hygienically mite-proof and antibacterial. Mattress cover has zipper closure and is completely removable and washable.

Orthopädische Matratze, Höhe 25 cm, mit sieben verschiedenen Belastungszonen. Die Matratze besteht aus einem Super-Mikro-Taschenfederkern, mit einem Belag aus verschieden hohem, hochelastischem Polyurethanschaum (Memory Foam). Die Federtaschen sind aus antiallergischem Stoff, geschlossen im Ultraschall-Schweißverfahren, was die Matratze besonders bequem macht. Die Matratze ist drehbar und ist mit dem cremefarbenen Jacquard-Stoff "Minotti" bezogen, gegen Milben und antibakteriell behandelt. Der Bezug mit Reißverschluss ist voll abzieh- und waschbar.

Matelas orthopédique h 25 cm, à sept zones de portance différenciée. Le matelas est constitué de ressorts "super micro" ensachés, recouverts d'une couche de polyuréthane expansé à haute résilience et à hauteurs différentes à mémoire de forme (Memory Foam). Le sachet contenant le ressort, en tissu anallergique et soudé aux ultrasons, rend la suspension du matelas particulièrement confortable. Le matelas est réversible et est recouvert d'un tissu jacquard "Minotti", couleur crème, traité anti-acariens et antibactérien. revêtement muni de fermeture à glissière, entièrement déhoussable et lavable.

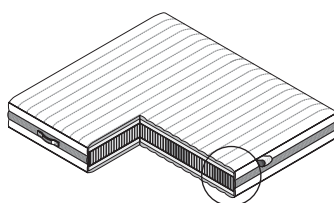
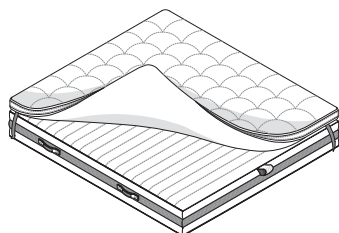

DIMENSIONI MATERASSO MATTRESS DIMENSIONS

160x200
63x783/4

180x200
707/8x783/4

200x200
783/4x783/4

153x203
601/4x80

193x203
76x80

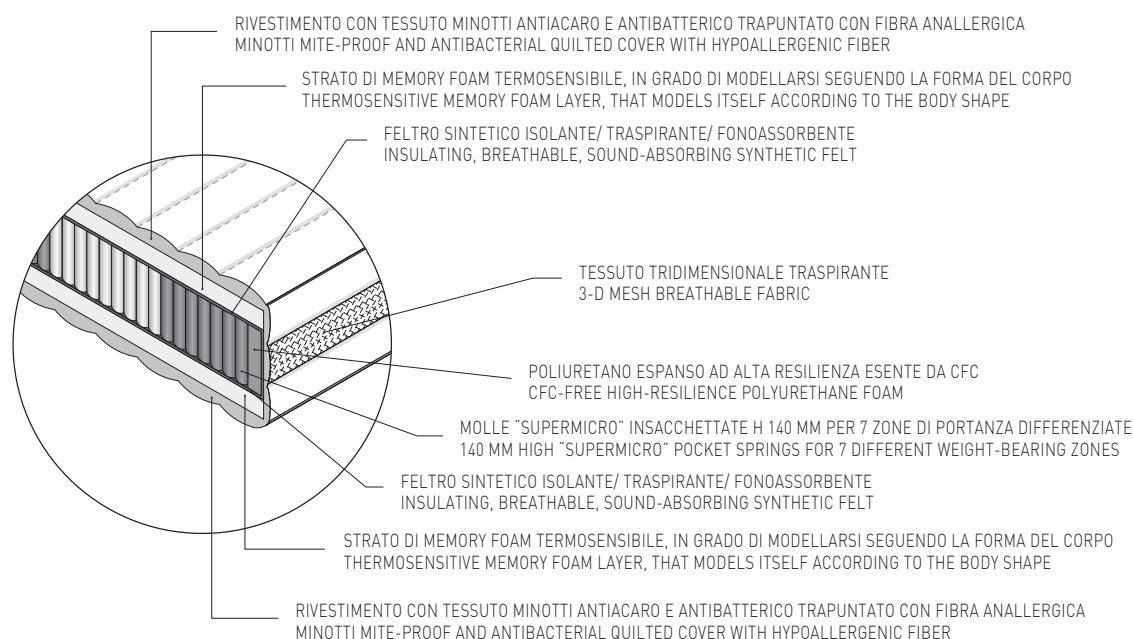

MINORE PORTANZA
LOWER WEIGHT-BEARING CAPACITY



MAGGIORE PORTANZA
HIGHER WEIGHT-BEARING CAPACITY



7 ZONE DI PORTANZA DIFFERENZIATE
7 DIFFERENT WEIGHT-BEARING ZONES

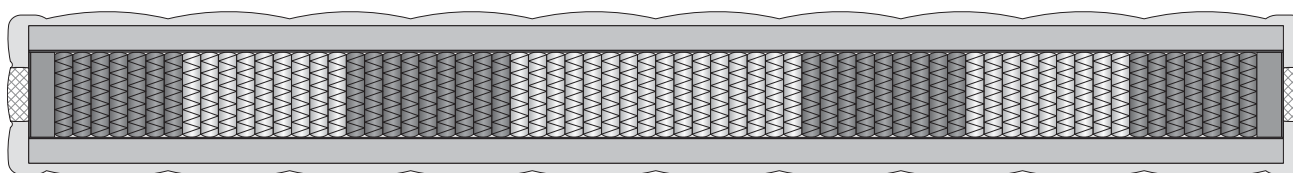



MOLLEGGIO SUPER MICROPOCKET A 7 ZONE / SUPER MICROPOCKET 7-AREA SPRINGS

MORBIDEZZA STRAORDINARIA CON LA MOLLA CHE SI COMPRIME CON UN DITO
EXTRAORDINARY SOFTNESS OF THE SPRING WHICH COMPRESSES WITH THE PUSH OF A FINGER

N. ZONE DIFFERENZIATE / NO. OF DIFFERENTIATED AREAS

ALTEZZA MOLLA / HEIGHT OF SPRINGS

DIAMETRO TESTA MOLLA / SPRING HEAD DIAMETER

DIAMETRO FILO ACCIAIO / STEEL THREAD DIAMETER

CATEGORIA MOLLE (QUANTITÀ) CM 160X200 / SPRING CATEGORY (QUANTITY)CM 160X200

7

140 MM

25 MM

0,9 - 1,0 MM

3000

TESSUTO TRIDIMENSIONALE TRASPIRANTE 3-D MESH BREATHABLE FABRIC

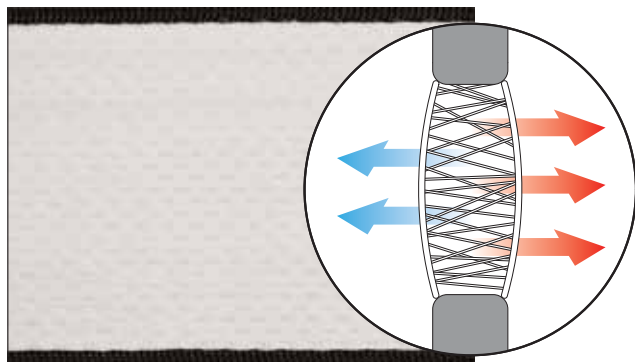

NUOVO TESSUTO TRIDIMENSIONALE COMPOSTO DA TRE STRATI CHE GENERANO UN'INTERCAPEDINE INTERNA DOVE CIRCOLA LIBERAMENTE L'ARIA. UNA FASCIA TRASPIRANTE CONTINUA SUL BORDO DEL MATERASSO PERMETTE DI MANTENERLO PIÙ FRESCO E ASCIUTTO, GRAZIE AL FLUSSO CONTINUO D'ARIA CHE NE FAVORISCE IL RICIRCOLO.

NEW THREE-DIMENSIONAL MATERIAL, CONSISTING OF THREE LAYERS WHICH CREATE AN INTERNAL THREE-DIMENSIONAL GAP WHERE AIR CAN CIRCULATE FREELY. A TRANSPIRING HEM RUNS ALONG THE EDGE OF THE MATTRESS ENABLING IT TO STAY FRESHER AND DRIER, SINCE THE CONTINUOUS AIRFLOW HELPS IT RECYCLE.

MATERASSINO / TOPPER "COMFORT" H5

Materassino imbottito in dacron 900g/mq, fibra anallergica elastica con basso coefficiente trasmissione di calore, altezza cm 5, provvisto di elastici agli angoli per fissaggio al materasso. Il topper, posizionato tra il materasso e il lenzuolo, dona una particolare sensazione di morbidezza e confort. È rivestito in tessuto jacquard "Minotti", colore Crema, antibatterico e antibatterico. Rivestimento con cerniera completamente sfoderabile e lavabile.

Padded mattress topper in Dacron 900g/sq m, 5 cm h, made of elastic, non-allergic fibres with low heat transmission, is held in place over the mattress by elastic straps on the corners. Placed between the mattress and the sheet, the topper lends added sensation of softness and comfort. Covered in cream color "Minotti" jacquard fabric that is antibacterial and MITE-proof. Cover has zipper closure and is completely removable and washable.

Matratzenauflage mit Dacron-Füllung 900g/m, aus elastischen antiallergischen Fasern mit geringer Wärmeübertragung, Höhe 5 cm, mit Spanngummis zur Befestigung an der Matratze. Die Auflage, zwischen Matratze und Laken, vermittelt ein besonderes Gefühl von Weichheit und Komfort. Mit dem cremefarbenen Jacquard-Stoff "Minotti" bezogen, antibakterielle UND gegen Milben behandelt. Der Bezug mit Reißverschluss ist voll abzieh- und waschbar.

Petit matelas rembourré en Dacron 900g/m², en fibres élastique anallergique, avec faible transmission de la chaleur, hauteur 5 cm, muni d'élastiques aux angles pour le fixer au matelas. Cette couche de confort, située entre le matelas et le drap, donne une sensation particulière de souplesse et de confort. Elle est recouverte de tissu jacquard "Minotti", couleur crème, traité anti-acariens et antibactérien. Revêtement muni de fermeture à glissière, entièrement déhoussable et lavable.

DIMENSIONI TOPPER TOPPER DIMENSIONS

160X200
63X78^{3/4}

180X200
70^{7/8}X78^{3/4}

200X200
78^{3/4}X78^{3/4}

153X203
60^{1/4}X80

193X203
76X80

