



maarten victor carrasco

Swivel or 4 leg chair for the home and for public facilities. Its powder coated steel tube structure and its carefully made, elegant, upholstered seat recall the classics of the '70s. Maarten is available in two upholstered versions with or without arms to fit with all kind of environments. The 4 legs version is stackable

materials:

Swivel or 4 leg calibrated steel structure powder coated in thermoreinforced polyester in black, white, fluorescent orange and altea blue. Moulded shell with 3D plywood covered in shape-holding polyurethane foam and polyester fiber. Fixed upholstery covering available in the classic and plain version. Arms available in calibrated steel powder coated in thermoreinforced polyester in the same colors as the structure.

STRUCTURE | ARMS

Lacquered



White
RAL 9003



Black
RAL 9005



Altea Blue
RAL 5000



Sand
NCS 3005Y50R



Fluorescent Orange
RAL 2005

Stained



Matt
oak



Wenge



Cognac



Ash

dimensions:

FOUR LEG BASE SMOOTH UPHOLSTERY

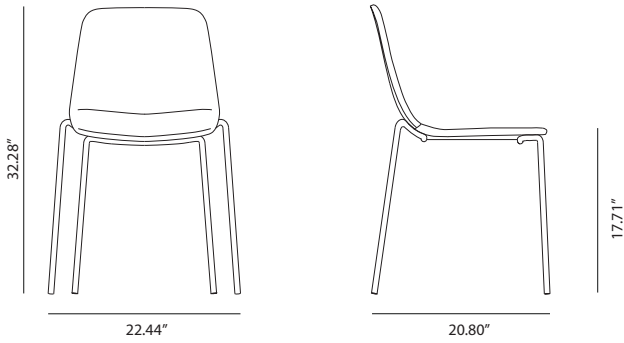

SWIVEL BASE SMOOTH UPHOLSTERY

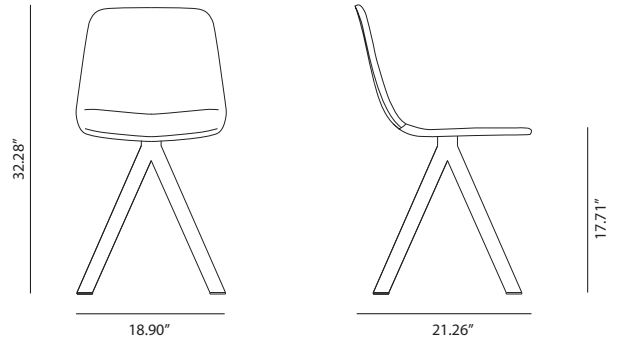

AUDITORIUM SEAT SMOOTH UPHOLSTERY

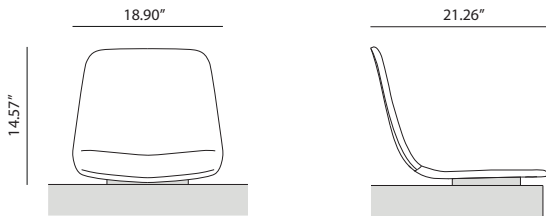

ARMS

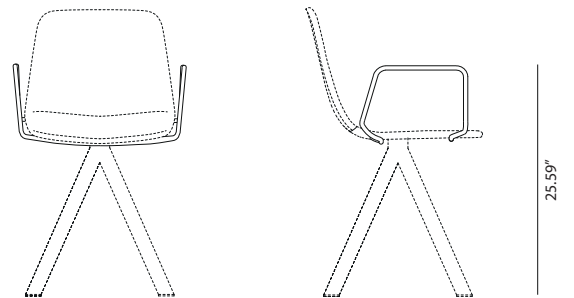

FOUR LEG BASE SOFT UPHOLSTERY

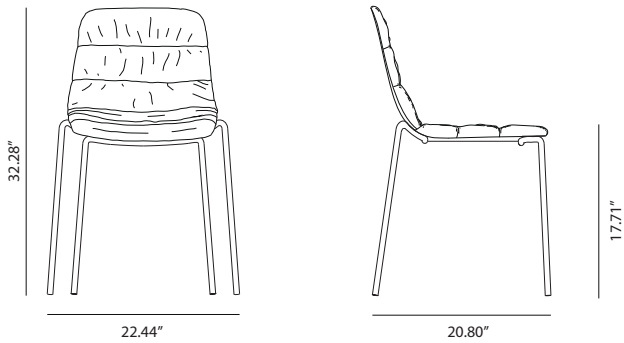

SWIVEL BASE SOFT UPHOLSTERY

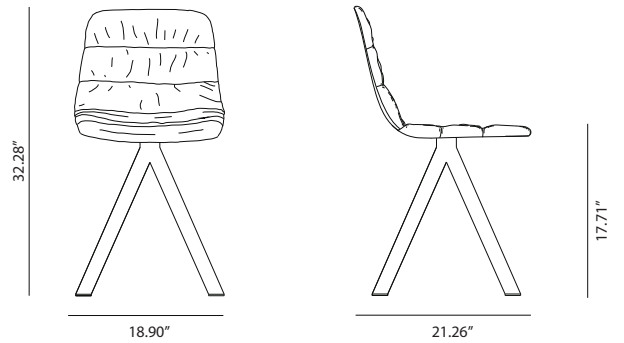

AUDITORIUM SEAT SOFT UPHOLSTERY

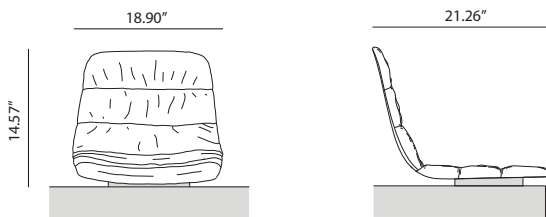

MAABRM - WOODEN ARMS

Calibrated steel arms powder coated in thermoreinforced polyester in black, sand, altea blue or flourescent orange, with natural oak armrests.

ARMS

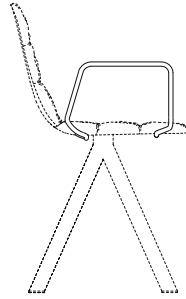
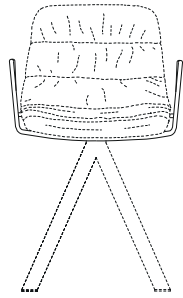

25.59"

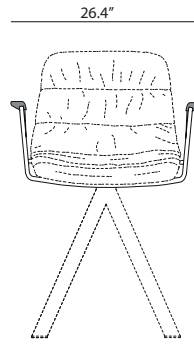

26.4"

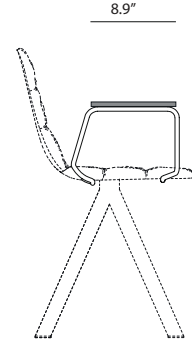

8.9"

22.8"