

mdf italia



© COPYRIGHT 2024 MDF ITALIA SRL SOCIETA' UNIPERSONALE

2024

ARRAY SOFA SYSTEM

Designed by Snøhetta

Array is a sofa system designed by Snøhetta to offer maximum flexibility and comfort.

It represents a new approach to sofa design and construction, with the goal of reducing environmental impact, achieving customised living solutions, and simplifying logistics. To this end, it introduces small modules, which permit a variety of layouts, are easy to transport, and can be easily disassembled and reassembled for replacement or recycling. The concept of comfort extends to the entire supply chain, moving beyond its ergonomic component.

The Array collection is developed from both a micro and macro perspective and is suitable for residential and contract contexts.

STRUCTURE

The structure is made from an injection moulded base in recycled polypropylene. The process leaves a hollow cavity in the centre in order to use as little material as possible.

The seat and backrest are moulded in Bio polyurethane foam, and designed to maximise comfort.

The hidden fastening system is made of glass-filled nylon.

The upholstery is made to enhance softness, and cover every part of the sofa. It is also completely removable.

The fabric cover is also available in recycled polyester.

MODULES AND ACCESSORIES

The system includes the following modules: straight module with backrest, module for external curve, module for inside curve, straight pouf module, curved pouf module.

The Array system is completed with three coffee tables in wood with veneer in the finishes bleached oak, brown oak and canaletto walnut. Available in two variants: freestanding coffee table and side table to be inserted between the padded modules.

Abacus

straight module with backrest

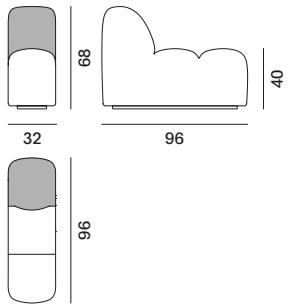

module for external curve

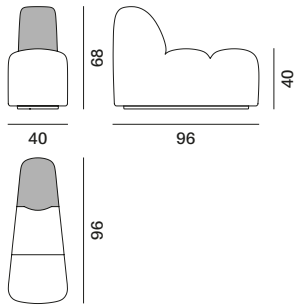

module for inside curve

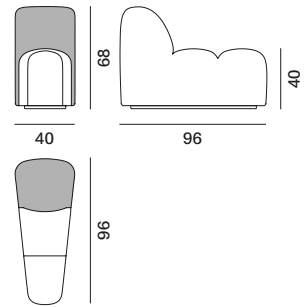

straight pouf module

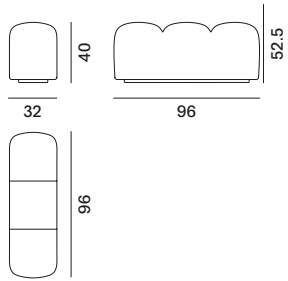

curved pouf module

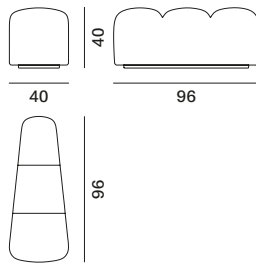

coffee tables

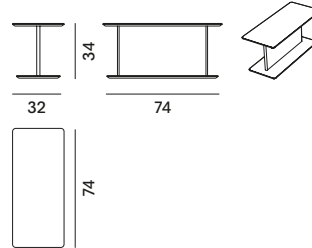
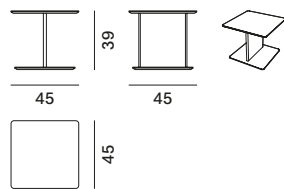
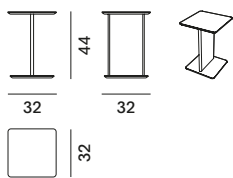

side table

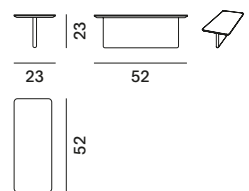

Abacus

examples of compositions

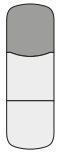

straight module with backrest

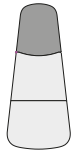

module for external curve

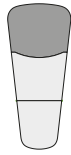

module for inside curve



straight pouf module



curved pouf module

COMPOSITION A

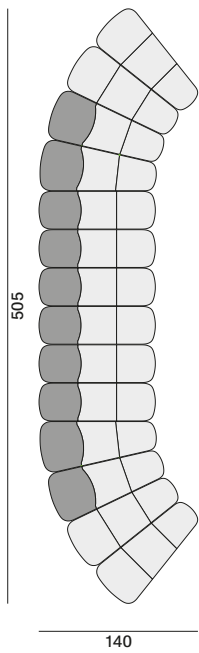

COMPOSITION B

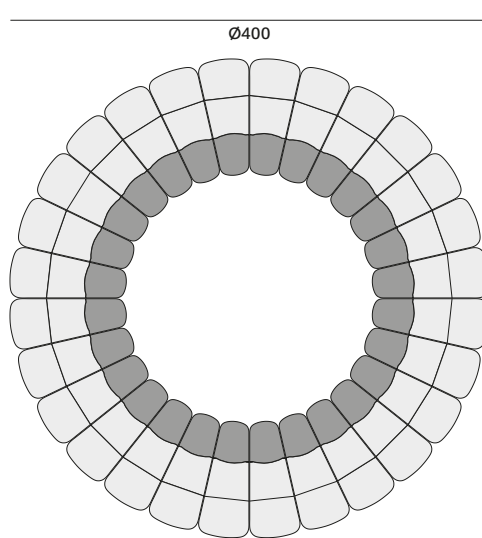

COMPOSITION C

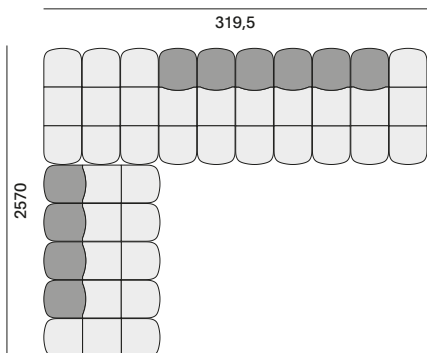

COMPOSITION D

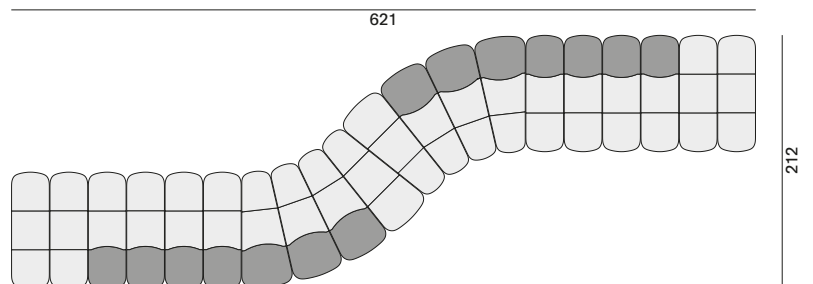

Abacus

examples of compositions

COMPOSITION E

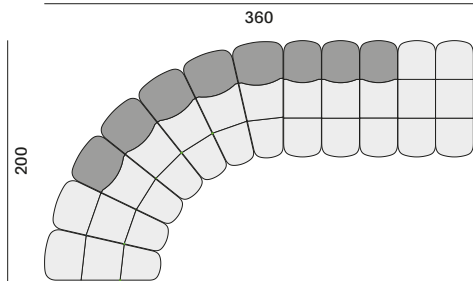

COMPOSITION F

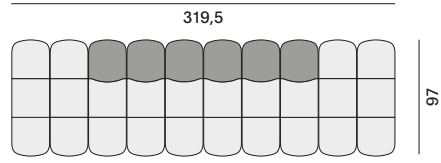

COMPOSIZIONE G

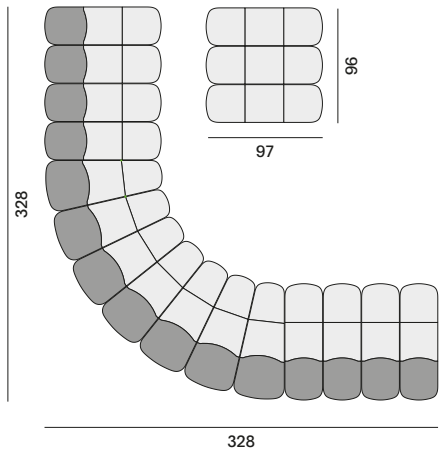

COMPOSITION H

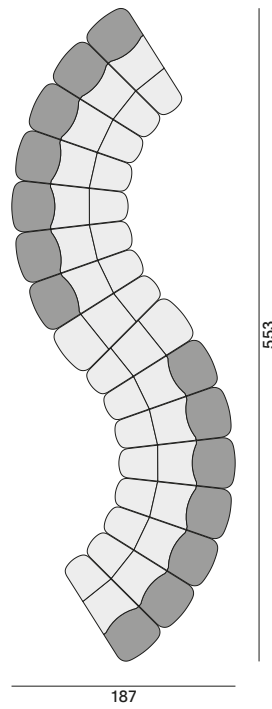

255,5

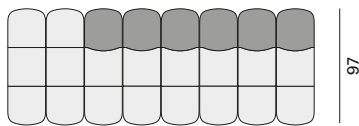

COMPOSITION L

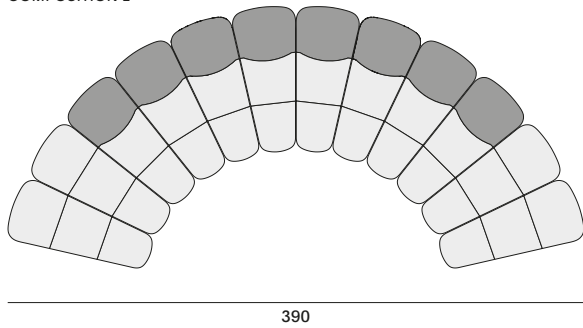

COMPOSITION M

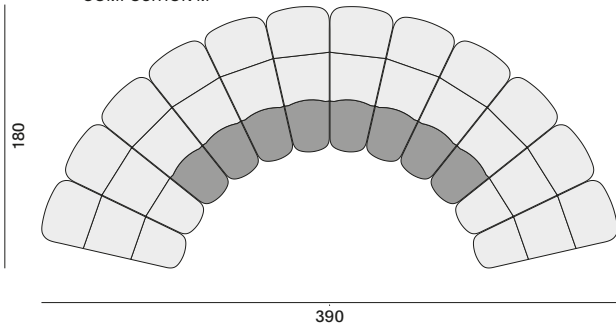

Finish options

TOP/STRUCTURE

Wood



Canaletto
walnut



Bleached oak
X075



Brown oak
X076

COVER
