



add t francesco roto

The ADD T series of modular tables are the new members of the ADD family, suitable for versatile environments such as the home, the office or the restaurant. The subtle lines and facet surface of the legs that connect in the extrusion of the frame, give lightness and formal richness to the product. The top, implemented in timber or laminated Fenix remains raised in 3mm above the frame, like a floating plane, complimenting the refined design.

materials:

Die cast aluminum legs in powder coated white with tops in HPL white Fenix or blanché oak.

orange skin

223 west erie street,
chicago, il., 60610
t: 312 335 1033 f: 312 335 1025
showroom@orangeskin.com
www.orangeskin.com

dimensions:

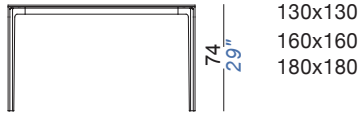

130x130
160x160
180x180



90x160
90x180
90x200
110x250
110x300

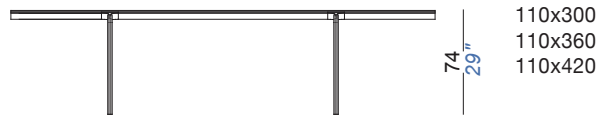
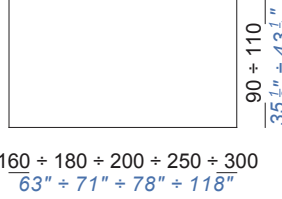
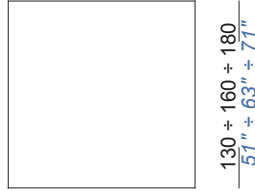

110x300
110x360
110x420

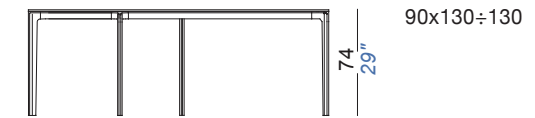

90x130÷130

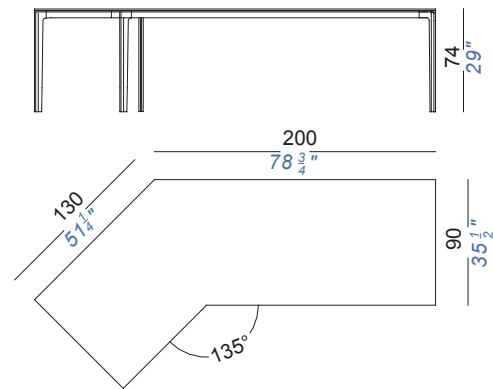
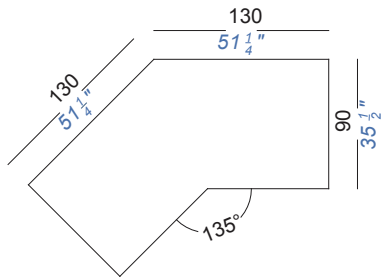
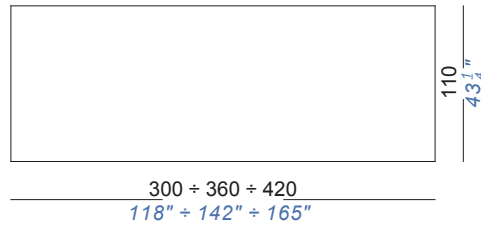

90x200÷130

